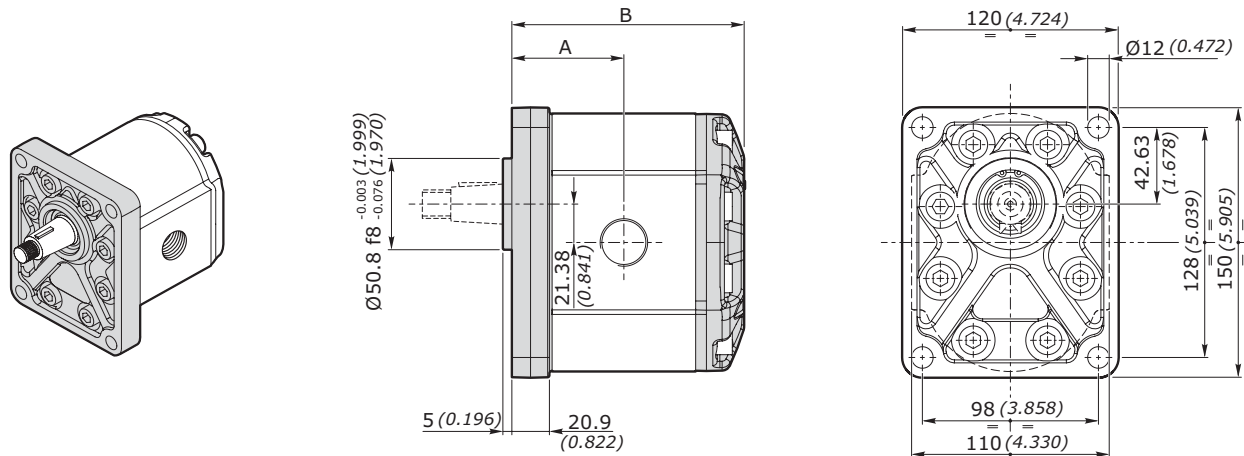

POMPE AD INGRANAGGI GRUPPO 3GP
GEAR PUMPS GROUP 3GP
FLANGIA EUROPEA EUR EUROPEAN FLANGE
FLANGIA E COPERCHIO IN GHISA - CAST IRON FLANGE AND COVER

GRUPPO GROUP 3GP	CILINDRATA DISPLACEMENT		PRESSIONE MAX - MAX PRESSURE						VELOCITÀ MAX MAX SPEED	PORTATA MAX MAX FLOW		VELOCITÀ MIN MIN SPEED	PORTATA MIN MIN FLOW		RENDIMENTO VOLUMETRICO MIN. MIN. VOLUMETRIC EFFICIENCY
			P1		P2		P3								
	cm ³ /giro	in ³ /rev	bar	psi	bar	psi	bar	psi	giri/min - rpm	l/min	Gal/ min	giri/min - rpm	l/min	Gal/ min	%
3GP 190	19.3	1.2	250	3625	270	3915	300	4350	3500	67.6	17.84	700	12.8	3.39	95*
3GP 230	23.0	1.4	240	3480	260	3770	290	4205	3500	80.3	21.22	700	15.5	4.03	95*
3GP 300	30.2	1.8	220	3190	240	3480	260	3770	3300	99.7	26.33	700	20.1	5.31	95*
3GP 340	33.8	2.1	220	3190	230	3335	260	3770	3300	111.6	29.49	700	22.5	5.94	95*
3GP 370	37.5	2.3	210	3045	230	3335	250	3625	3300	123.6	32.66	700	24.9	6.58	95*
3GP 440	44.6	2.7	200	2900	220	3190	240	3480	3000	133.8	35.35	700	29.7	7.84	95*
3GP 530	53.0	3.2	200	2900	210	3045	240	3480	3000	159.1	42.04	700	35.3	9.32	95*
3GP 620	62.7	3.8	180	2610	190	2755	200	2900	2500	156.8	41.41	700	41.7	11.01	95*
3GP 700	70.5	4.3	180	2610	200	2900	208	3016	2500	176.3	46.58	700	46.9	12.39	95*
3GP 770	77.2	4.7	170	2465	190	2755	196	2842	2200	169.8	44.84	700	51.3	13.56	95*

DIMENSIONI • DIMENSIONS

GRUPPO - GROUP 3	A		B		MASSA - MASS	
	mm	inch	mm	inch	kg	lbs
3GP 190	62.4	2.456	128.3	5.051	7.67	16.91
3GP 230	63.9	2.515	131.3	5.169	7.81	17.21
3GP 300	66.9	2.633	137.3	5.405	8.09	17.82
3GP 340	68.4	2.692	140.3	5.523	8.22	18.12
3GP 370	69.9	2.751	143.3	5.641	8.36	18.43
3GP 440	72.9	2.870	149.3	5.877	8.64	19.04
3GP 530	76.4	3.007	156.3	6.153	8.96	19.75
3GP 620	80.4	3.165	164.3	6.468	9.33	20.56
3GP 700	86.9	3.421	170.8	6.724	9.63	21.22
3GP 770	92.4	3.637	176.3	6.940	9.88	21.77

POMPE AD INGRANAGGI GRUPPO 3GP
GEAR PUMPS GROUP 3GP

CODICE ORDINAZIONE • ORDER CODE

3GP - G - 340 - D - EUR - B - N - 10 - 0 - G

SIGLA - CODE	TIPO - TYPE	DESCRIZIONE - DESCRIPTION	PAGINA - PAGE
3GP	Tipo pompa <i>Pump type</i>	Pompa singola gruppo 3 <i>Single pump group 3</i>	6
G	Materiale flangia e coperchio <i>Flange and cover material</i>	G = Ghisa / <i>Cast iron</i>	
340	Cilindrata <i>Displacement</i>	Cilindrata = 33.8 cm ³ /giro <i>Displacement = 2.1 in³/rev</i>	6
D	Senso di rotazione <i>Rotation type</i>	D = Rotazione destra / <i>Clockwise rotation</i> S = Rotazione sinistra / <i>Anticlockwise rotation</i>	8
EUR	Tipo Flangia <i>Flange type</i>	Flangia standard europea <i>European standard flange</i>	
B	Tipo anello di tenuta <i>Seal ring type</i>	Vedi tabella compatibilità <i>See compatibility table</i>	62
N	Tipo guarnizione <i>Gasket type</i>	N = NBR V = Viton	
10	Tipo Albero <i>Shaft type</i>	Vedi tabella compatibilità <i>See compatibility table</i>	63
0	Posizione connessione <i>Connection position</i>	Vedi tabella compatibilità <i>See compatibility table</i>	65
G	Tipo connessione <i>Connection type</i>	Vedi tabella compatibilità <i>See compatibility table</i>	



POMPE AD INGRANAGGI GRUPPO 3GP
GEAR PUMPS GROUP 3GP
TIPOLOGIA FLANGIA • FLANGE TYPE

	EUR	SAEB	SAEBOR	ZFC
3GP				
A alluminio aluminium	non disponibile not available	non disponibile not available	non disponibile not available	non disponibile not available
G ghisa cast iron	◇	◇	◇	◇

 ◇ = Combinazione standard - *Standard combination*
ANELLO DI TENUTA • SEAL RING

SIGLA - CODE	TIPO - TYPE	DESCRIZIONE - DESCRIPTION
B	Anello di tenuta fino a 3 bar <i>Sealing ring up to 3 bar</i>	Per bassissime pressioni <i>For very low pressure</i>
H	Anello di tenuta fino a 8 bar <i>Sealing ring up to 8 bar</i>	Per basse pressioni (con distanziali di rinforzo) <i>For low pressure (with stiffening seal)</i>
K	Anello di tenuta fino a 30 bar <i>Sealing ring up to 30 bar</i>	Per alte pressioni <i>For high pressure</i>

COMBINAZIONE FLANGIA - ANELLO DI TENUTA - GUARNIZIONE • FLANGE - SEAL RING - GASKET COMBINATION

		EUR			SAEB			SAEBOR			ZFC
		Anello - seal ring			Anello - seal ring			Anello - seal ring			Anello - seal ring
		B	H	K	B	H	K	B	H	K	B
NBR	N	◇	◇	◇	◇	◇	◇	◇	◇	◇	◇
Viton	V	●	●	●	●	●	●	●	●	●	●

 ◇ = Combinazione standard - *Standard combination*

 ● = Combinazione disponibile - *Available combination*

 esempio • example: **3GP - G - 340 - D - EUR - B - N - 10 - 0 - G**
EUR = Flangia europea / *European flange*
B = Anello tenuta fino a 3 bar / *Seal ring up to 3 bar*
N = Guarnizione in NBR / *NBR o-ring*

POMPE AD INGRANAGGI GRUPPO 3GP
GEAR PUMPS GROUP 3GP

COMBINAZIONE ALBERO - FLANGIA • SHAFT - FLANGE COMBINATION

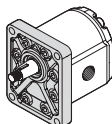
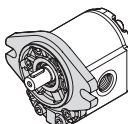
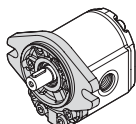
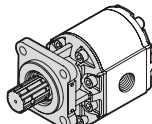
3GP	EUR	SAEB	SAEBOR	ZFC
				
10 Conico 1:8 <i>Tapered 1:8</i>	◆	●	●	
13 Cilindrico SAEB <i>SAEB Parallel shaft</i>	●	◆	◆	
14 Scanalato SAEB 13 denti (38.2) <i>SAEB 13T splined (38.2)</i>	●	◆	◆	
14R Scanalato SAEB 13 denti (44.7) <i>SAEB 13T splined (44.7)</i>	●	●	●	
24 Scanalato UNI8953 <i>UNI8953 Splined</i>				◆

◆ = Combinazione standard - *Standard combination*

● = Combinazione disponibile - *Available combination*

POMPE AD INGRANAGGI GRUPPO 3GP
GEAR PUMPS GROUP 3GP
3GP

DIMENSIONI ALBERO - SHAFT DIMENSIONS

10

 Conico 1:8
 Tapered 1:8

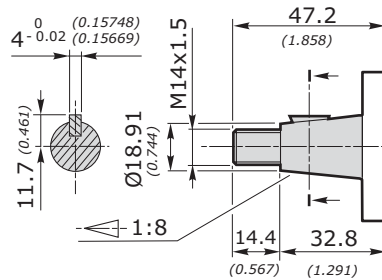
 Coppia 240 Nm
 Torque 178 ft-lbs

 Disponibile per - available for: **EUR - SAEB - SAEBOR**
13

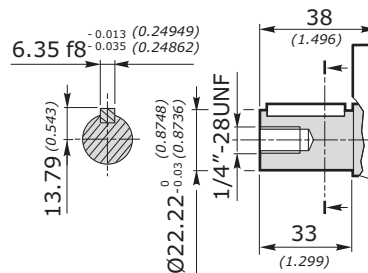
 Cilindrico SAEB
 SAEB Parallel
 shaft

 Coppia 200 Nm
 Torque 148 ft-lbs

 Disponibile per - available for: **EUR - SAEB - SAEBOR**
14

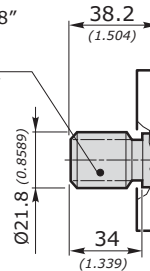
 Scanalato SAEB
 13 denti (38.2)
 SAEB 13T
 splined (38.2)

 Coppia 270 Nm
 Torque 200 ft-lbs

 Profilo scanalato 7/8"
 SAE 16/32 DP
 n. Denti = 13
 Splined profile 7/8"
 SAE 16/32 DP
 nr. of teeth = 13

 Disponibile per - available for: **EUR - SAEB - SAEBOR**
14R

 Scanalato SAEB
 13 denti (44.7)
 SAEB 13T
 splined (44.7)

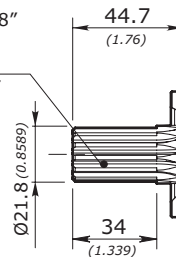
 Coppia 270 Nm
 Torque 200 ft-lbs

 Profilo scanalato 7/8"
 SAE 16/32 DP
 n. Denti = 13
 Splined profile 7/8"
 SAE 16/32 DP
 nr. of teeth = 13

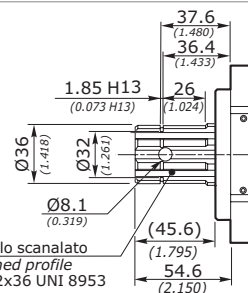
 Disponibile per - available for: **EUR - SAEB - SAEBOR**
24

 Scanalato
 UNI8953
 UNI8953
 Splined

 Coppia 330 Nm
 Torque 245 ft-lbs

 Profilo scanalato
 Splined profile
 8x32x36 UNI 8953

 Disponibile per - available for: **ZFC**

POMPE AD INGRANAGGI GRUPPO 3GP
GEAR PUMPS GROUP 3GP

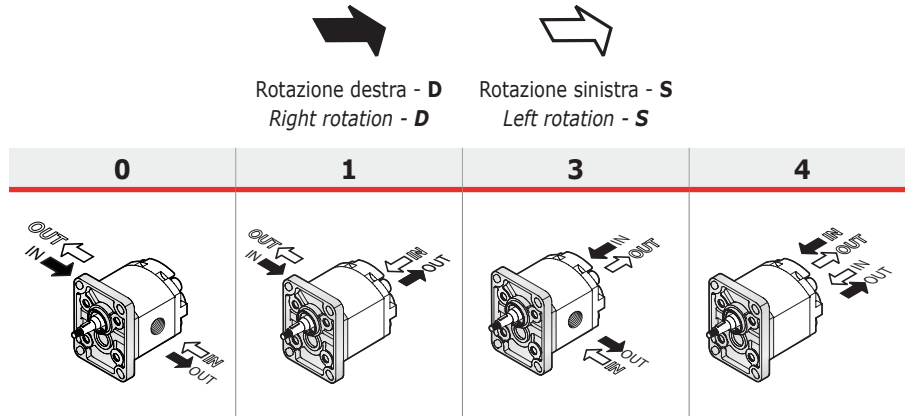
POSIZIONE CONNESSIONE • CONNECTION POSITION



Il segno del corpo indica il lato aspirazione per le pompe
The sign on the body identify the suction side for the pumps

IN = ASPIRAZIONE - SUCTION
OUT = MANDATA - DELIVERY

TIPO CONNESSIONE • CONNECTION TYPE

Le connessioni rappresentate corrispondono alle versioni standard; per connessioni differenti, contattare il nostro Ufficio Commerciale. *The connections type shown correspond to standard configuration; for different applications contact our Commercial Dept.*

3GP		POSIZIONE CONNESSIONE - CONNECTION POSITION			
		0	1	3	4
GAS	G	◇	◇	◇	◇
UNF	W	◇	◇	◇	◇
FLANGIATE FLANGED	T	◇			
	N	◇			
	F	◇			

GAS	UNI ISO 228/1	SIGLA CODE	CIL. DISPL.	ASPIRAZIONE - SUCTION IN			MANDATA - DELIVERY OUT		
				A	B		A	B	
		G	190	G 1"	20 [mm] 0.788 [inch]	70 [Nm] 620 [in.lbs]	G 3/4"	17 [mm] 0.670 [in.lbs]	60 [mm] 531 [in.lbs]
			230						
			300						
			340						
			370						
			440						
			530						
			630						
			700						
			770						

POMPE AD INGRANAGGI GRUPPO 3GP
GEAR PUMPS GROUP 3GP

UNF	ANSI/ASME B1.1	SIGLA CODE	CIL. DISPL.	ASPIRAZIONE SUCTION IN			MANDATA DELIVERY OUT		
				A	B		A	B	
		W	190	SAE 16 1"5/16-12 UN	20 [mm] 0.788 [inch]	70 [Nm] 620 [in.lbs]	SAE 12 1"1/16-12 UN	20 [mm] 0.788 [inch]	60 [Nm] 531 [in.lbs]
			230						
			300						
			340						
			370						
			440						
			530						
			630						
			700						
			770						

FLANGIATE FLANGED	ISO/R 262	SIGLA CODE	CIL. DISPL.	ASPIRAZIONE SUCTION IN					MANDATA DELIVERY OUT				
				A	B	C	D		A	B	C	D	
		T	190	26 [mm] 1.024 [inch]	55 [mm] 2.167 [inch]	M8	16 [mm] 0.630 [inch]	15 [Nm] 133 [in.lbs]	18 [mm] 0.709 [inch]	55 [mm] 2.167 [inch]	M8	16 [mm] 0.630 [inch]	15 [Nm] 133 [in.lbs]
			230										
			300										
			340										
			370										
			440										
			530										
			630										
			700										
			770										

FLANGIATE FLANGED	ISO/R 262	SIGLA CODE	CIL. DISPL.	ASPIRAZIONE SUCTION IN					MANDATA DELIVERY OUT						
				A	B	C	D	E		A	B	C	D	E	
		F	190	27 [mm] 1.063 [inch]	26.2 [mm] 1.031 [inch]	52.4 [mm] 2.063 [inch]	M8	15 [mm] 0.591 [inch]	15 [Nm] 71 [in.lbs]	24 [mm] 0.945 [inch]	26.2 [mm] 1.031 [inch]	52.4 [mm] 2.063 [inch]	M8	15 [mm] 0.591 [inch]	15 [Nm] 71 [in.lbs]
			230												
			300												
			340												
			370												
			440												
			530												
			630												
			700												
			770												