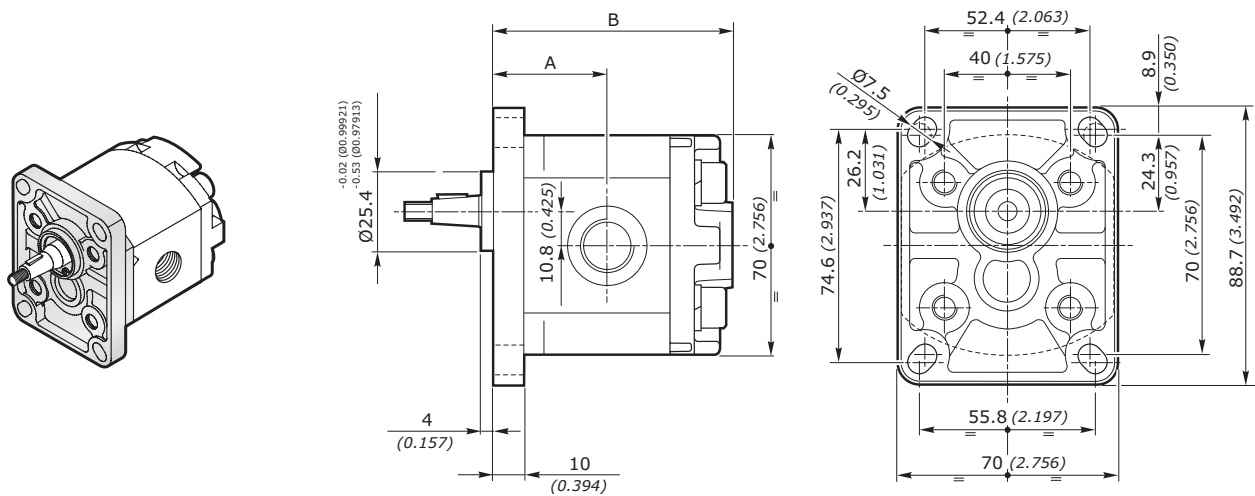

POMPE AD INGRANAGGI GRUPPO 1SP
GEAR PUMPS GROUP 1SP
FLANGIA EUROPEA **EUR** **STANDARD FLANGE**

GRUPPO GROUP 1SP	CILINDRATA DISPLACEMENT		PRESSIONE MAX - MAX PRESSURE						VELOCITÀ MAX MAX SPEED	PORTATA MAX MAX FLOW		VELOCITÀ MIN MIN SPEED	PORTATA MIN MIN FLOW		RENDIMENTO VOLUMETRICO MIN. MIN. VOLUMETRIC EFFICIENCY
	cm ³ /giro	in ³ /rev	P1		P2		P3			l/min	Gal/min		l/min	Gal/min	
			bar	psi	bar	psi	bar	psi	giri/min - rpm			%			
1SP 009	0.89	0.05	240	3480	260	3770	290	4205	6000	5.3	1.40	600	0.49	0.13	92*
1SP 012	1.18	0.07	240	3480	260	3770	290	4205	6000	7.1	1.88	600	0.65	0.17	92*
1SP 016	1.6	0.10	240	3480	260	3770	290	4205	6000	9.6	2.54	400	0.61	0.16	95*
1SP 020	2.0	0.12	220	3190	250	3625	270	3915	5500	11	2.91	400	0.76	0.20	95*
1SP 025	2.5	0.15	220	3190	250	3625	270	3915	5000	12.5	3.30	400	0.95	0.25	95*
1SP 032	3.2	0.20	210	3045	240	3480	260	3770	4500	14.4	3.80	400	1.21	0.32	95*
1SP 037	3.7	0.23	210	3045	240	3480	260	3770	4000	14.8	3.91	400	1.40	0.37	95*
1SP 042	4.2	0.26	190	2755	210	3045	230	3335	3500	14.7	3.88	400	1.60	0.42	95*
1SP 050	5.0	0.31	180	2610	210	3045	230	3335	3000	15	3.96	400	1.90	0.50	95*
1SP 063	6.3	0.38	170	2465	190	2755	210	3045	2700	17	4.49	400	2.39	0.63	95*
1SP 078	7.76	0.47	170	2465	190	2755	210	3045	2500	19.4	5.13	400	2.95	0.78	95*
1SP 098	9.78	0.60	150	2175	170	2465	190	2755	2000	19.6	5.18	400	3.71	0.98	95*

DIMENSIONI • DIMENSIONS

GRUPPO - GROUP 1	A		B		MASSA - MASS	
	mm	inch	mm	inch	kg	lbs
1SP 009	34.80	1.370	73.6	2.898	0.91	2.01
1SP 012	35.35	1.392	74.7	2.941	0.93	2.05
1SP 016	36.20	1.425	76.4	3.008	0.95	2.09
1SP 020	36.95	1.455	77.9	3.067	0.97	2.14
1SP 025	37.95	1.494	79.9	3.146	1.00	2.21
1SP 032	39.30	1.547	82.6	3.252	1.04	2.29
1SP 037	40.30	1.587	84.6	3.331	1.07	2.36
1SP 042	41.25	1.624	86.5	3.406	1.10	2.43
1SP 050	42.80	1.685	89.6	3.528	1.14	2.51
1SP 063	45.35	1.785	94.7	3.728	1.22	2.69
1SP 078	48.20	1.898	100.4	3.953	1.30	2.87
1SP 098	52.15	2.053	108.3	4.264	1.41	3.11

POMPE AD INGRANAGGI GRUPPO 1SP
GEAR PUMPS GROUP 1SP
FLANGIA PER MINICENTRALINA MC32 POWER-PACK FLANGE

GRUPPO GROUP 1SP	CILINDRATA DISPLACEMENT		PRESSIONE MAX - MAX PRESSURE						VELOCITÀ MAX MAX SPEED	PORTATA MAX MAX FLOW		VELOCITÀ MIN MIN SPEED	PORTATA MIN MIN FLOW		RENDIMENTO VOLUMETRICO MIN. MIN. VOLUMETRIC EFFICIENCY
	cm ³ /giro	in ³ /rev	P1		P2		P3			l/min	Gal/min		l/min	Gal/min	
			bar	psi	bar	psi	bar	psi	giri/min - rpm			%			
1SP 009	0.89	0.05	210	3045	240	3480	260	3770	6000	5.3	1.40	600	0.49	0.13	92*
1SP 012	1.18	0.07	210	3045	240	3480	260	3770	6000	7.1	1.88	600	0.65	0.17	92*
1SP 016	1.6	0.10	210	3045	240	3480	260	3770	6000	9.6	2.54	400	0.61	0.16	95*
1SP 020	2.0	0.12	210	3045	240	3480	260	3770	5500	11	2.91	400	0.76	0.20	95*
1SP 025	2.5	0.15	210	3045	240	3480	260	3770	5000	12.5	3.30	400	0.95	0.25	95*
1SP 032	3.2	0.20	200	2900	230	3335	250	3625	4500	14.4	3.80	400	1.21	0.32	95*
1SP 037	3.7	0.23	200	2900	230	3335	250	3625	4000	14.8	3.91	400	1.40	0.37	95*
1SP 042	4.2	0.26	180	2610	210	3045	230	3335	3500	14.7	3.88	400	1.60	0.42	95*
1SP 050	5.0	0.31	180	2610	210	3045	230	3335	3000	15	3.96	400	1.90	0.50	95*
1SP 063	6.3	0.38	170	2465	190	2755	210	3045	2700	17	4.49	400	2.39	0.63	95*
1SP 078	7.76	0.47	170	2465	190	2755	210	3045	2500	19.4	5.13	400	2.95	0.78	95*
1SP 098	9.78	0.60	150	2175	170	2465	190	2755	2000	19.6	5.18	400	3.71	0.98	95*

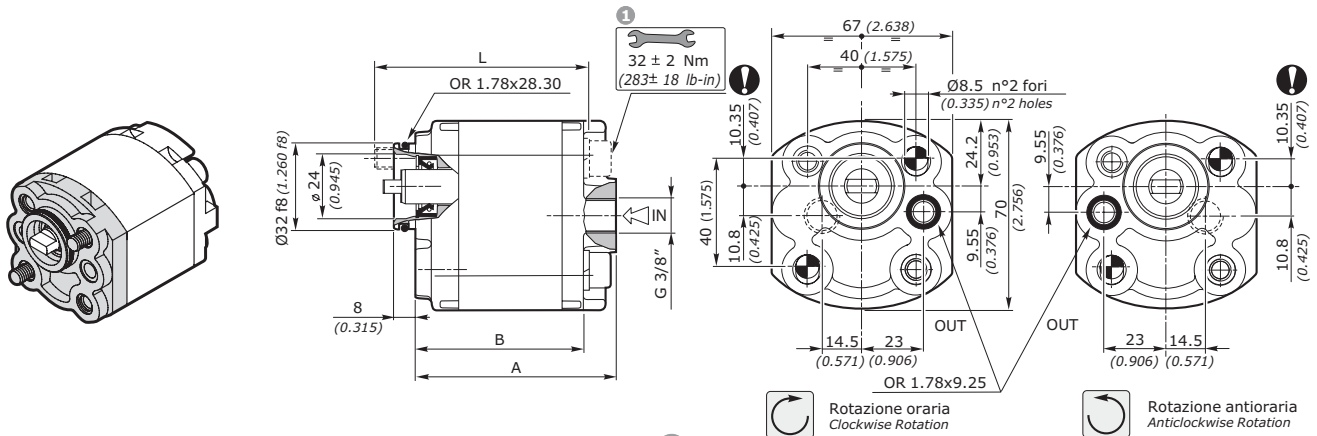
DIMENSIONI • DIMENSIONS

1 Coppia di serraggio viti: $32 \pm 2\text{Nm}$ (viti classe 10.9-12.9 UNI EN 20898/1)
 Il kit viti per il fissaggio della pompa è da ordinare separatamente.
 Codice di ordinazione: **0019W** (+ lunghezza **L** - vedi tabella)
 Il fissaggio della pompa può essere effettuato con 2 viti prigioniere ($25 \pm 2\text{Nm}$).
 Fissare la pompa mediante dadi autobloccanti ($32 \pm 2\text{Nm}$).

1 Tightening torque of screws: $283 \pm 18\text{lb-in}$ (screws 10.9-12.9 UNI EN 20898/1).
 The screws kit for the pump assembly should be ordered separately.
 Ordering code: **0019W** (+ length **L** - see table)
 The assembling of the pump should be effected by 2 screw ($221 \pm 18\text{lb-in}$).
 Fix the pump by self-locking nuts ($283 \pm 18\text{lb-in}$).

GRUPPO - GROUP 1	A		B		L 1		MASSA - MASS	
	mm	inch	mm	inch	mm	inch	kg	lbs
1SP 009	73.1	2.878	61.6	2.425	80	3.150	0.91	2.01
1SP 012	74.2	2.921	62.7	2.469	80	3.150	0.93	2.05
1SP 016	75.9	2.988	64.4	2.535	80	3.150	0.95	2.09
1SP 020	77.4	3.047	65.9	2.594	80	3.150	0.97	2.14
1SP 025	79.4	3.126	67.9	2.673	85	3.346	1.00	2.21
1SP 032	82.1	3.232	70.6	2.780	85	3.346	1.04	2.29
1SP 037	84.1	3.311	72.6	2.858	90	3.543	1.07	2.36
1SP 042	86.0	3.386	74.5	2.933	90	3.543	1.10	2.43
1SP 050	89.1	3.508	77.6	3.055	95	3.740	1.14	2.51
1SP 063	94.2	3.709	82.7	3.256	100	3.937	1.22	2.69
1SP 078	99.9	3.933	88.4	3.480	105	4.134	1.30	2.87
1SP 098	107.8	4.244	96.3	3.791	115	4.528	1.41	3.11

POMPE AD INGRANAGGI GRUPPO 1SP
GEAR PUMPS GROUP 1SP

CODICE ORDINAZIONE • ORDER CODE

1SP - A - 020 - D - EUR - B - N - 10 - 0 - G

SIGLA - CODE	TIPO - TYPE	DESCRIZIONE - DESCRIPTION	PAGINA - PAGE
1SP	Tipo pompa <i>Pump type</i>	Pompa singola - gruppo 1 <i>Single pump - group 1</i>	4
A	Materiale flangia e coperchio <i>Flange and cover material</i>	A = alluminio / <i>aluminium</i>	
020	Cilindrata <i>Displacement</i>	Cilindrata = 2 cm ³ /giro <i>Displacement = 0.12 in³/rev</i>	4
D	Senso di rotazione <i>Rotation type</i>	D = Rotazione destra / <i>Clockwise rotation</i> S = Rotazione sinistra / <i>Anticlockwise rotation</i>	8
EUR	Tipo Flangia <i>Flange type</i>	Flangia europea standard <i>Standard european flange</i>	
B	Tipo anello di tenuta <i>Seal ring type</i>	Vedi tabella compatibilità <i>See compatibility table</i>	26
N	Tipo guarnizione <i>Gasket type</i>	N = NBR V = Viton	
10	Tipo Albero <i>Shaft type</i>	Vedi tabella compatibilità <i>See compatibility table</i>	27
0	Posizione connessione <i>Connection position</i>	Vedi tabella compatibilità <i>See compatibility table</i>	30
G	Tipo connessione <i>Connection type</i>	Vedi tabella compatibilità <i>See compatibility table</i>	



POMPE AD INGRANAGGI GRUPPO 1SP
GEAR PUMPS GROUP 1SP
TIPOLOGIA FLANGIA • FLANGE TYPE

	EUR	SAEAA	MC32	E32BX - E32BC	E32CX - E32CC
1SP					
A alluminio aluminium	◇	◇	◇	◇	◇
G ghisa cast iron	non disponibile not available	non disponibile not available	non disponibile not available	non disponibile not available	non disponibile not available

◇ = Combinazione standard - Standard combination

ANELLO DI TENUTA • SEAL RING

SIGLA - CODE	TIPO - TYPE	DESCRIZIONE - DESCRIPTION
A	Flangia senza anello di tenuta Flange without seal ring	
B	Anello di tenuta fino a 3 bar Sealing ring up to 3 bar	Per bassissime pressioni For very low pressure
H	Anello di tenuta fino a 8 bar Sealing ring up to 8 bar	Per basse pressioni (con distanziale di rinforzo) For low pressure (with stiffening seal)
K	Anello di tenuta fino a 30 bar Sealing ring up to 30 bar	Per alte pressioni For high pressure

COMBINAZIONE FLANGIA - ANELLO DI TENUTA - GUARNIZIONE • FLANGE - SEAL RING - GASKET COMBINATION

1SP	EUR			SAEAA			MC32			E32BX	E32BC	E32CX	E32CC		
	Anello - seal ring			Anello - seal ring			Anello - seal ring			Anello - seal ring	Anello - seal ring	Anello - seal ring	Anello - seal ring		
	B	H	K	B	H	K	B	H	K	A	B	K	A	B	K
NBR N	◇	◇	◇	◇	◇	◇	◇	◇	◇	◇	◇	●	◇	◇	●
Viton V	●	●	●	●	●	●	●	●	●	●	●	●	●	●	●

◇ = Combinazione standard - Standard combination

● = Combinazione disponibile - Available combination

esempio • example:

1SP - A - 020 - D - EUR - B - N - 10 - 0 - G
EUR = Flangia europea / European flange

B = Anello tenuta fino a 3 bar / Seal ring up to 3 bar

N = Guarnizione in NBR / NBR o-ring

POMPE AD INGRANAGGI GRUPPO 1SP
GEAR PUMPS GROUP 1SP

COMBINAZIONE ALBERO - FLANGIA • SHAFT - FLANGE COMBINATION

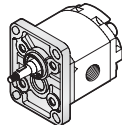
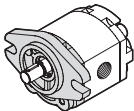
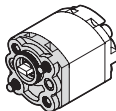
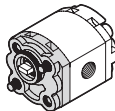
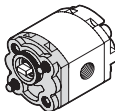
1SP	EUR	SAEAA	MC32	E32BX-E32BC	E32CX-E32CC
					
10 Conico 1:8 <i>Tapered 1:8</i>	◆	●	●		
11 Conico 1:5 <i>Tapered 1:5</i>	●	●	●		
13 Cilindrico SAEAA <i>Parallel shaft SAEAA</i>	●	◆			
14 Scanalato SAEAA 9 denti <i>SAEAA 9T splined</i>	●	◆			
15 Scanalato DIN 5480 6 denti 12x9 <i>DIN 5480 Splined</i>	●	●	●		
17 Fresato a dente frontale <i>Dihedral claw</i>				◆	◆
27 Fresato a dente frontale (con anello) <i>Dihedral claw (with sealing ring)</i>	●	●	◆		

◆ = Combinazione standard - *Standard combination*

● = Combinazione disponibile - *Available combination*

POMPE AD INGRANAGGI GRUPPO 1SP
GEAR PUMPS GROUP 1SP

1SP

DIMENSIONI ALBERO - SHAFT DIMENSIONS

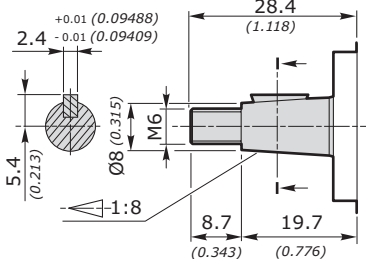
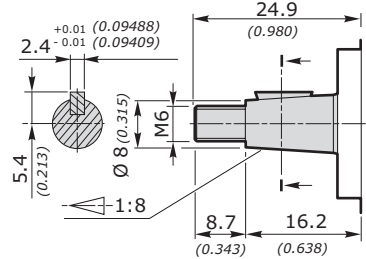
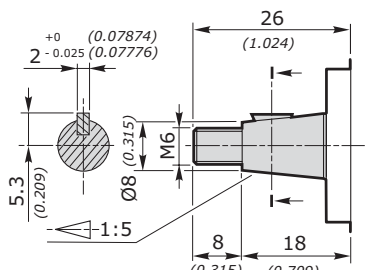
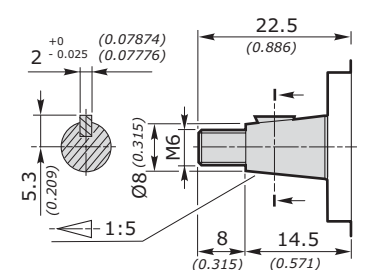
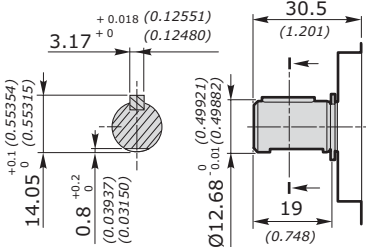
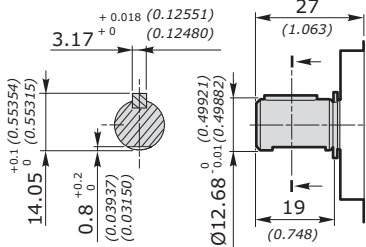
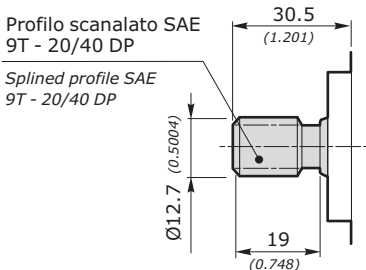
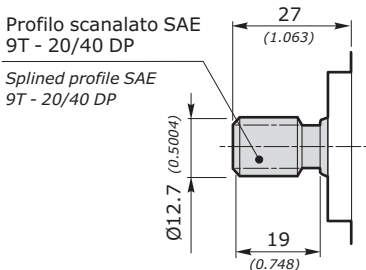
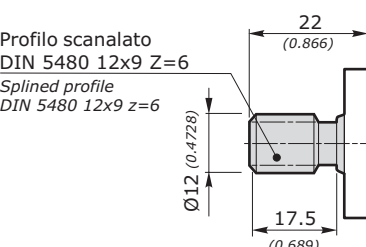
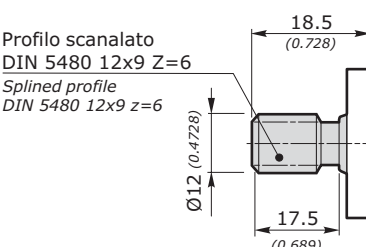
<p>10 Conico 1:8 Tapered 1:8</p> <p>Coppia 30 Nm Torque 22 ft-lbs</p>	 <p>Disponibile per - available for: EUR - MC32</p>	 <p>Disponibile per - available for: SAEAA</p>
<p>11 Conico 1:5 Tapered 1:5</p> <p>Coppia 30 Nm Torque 22 ft-lbs</p>	 <p>Disponibile per - available for: EUR - MC32</p>	 <p>Disponibile per - available for: SAEAA</p>
<p>13 Cilindrico SAEAA Parallel shaft SAEAA</p> <p>Coppia 35 Nm Torque 26 ft-lbs</p>	 <p>Disponibile per - available for: EUR</p>	 <p>Disponibile per - available for: SAEAA</p>
<p>14 Scanalato SAEAA 9 denti SAEAA 9T splined</p> <p>Coppia 40 Nm Torque 30 ft-lbs</p>	<p>Profilo scanalato SAE 9T - 20/40 DP</p> <p>Splined profile SAE 9T - 20/40 DP</p>  <p>Disponibile per - available for: EUR</p>	<p>Profilo scanalato SAE 9T - 20/40 DP</p> <p>Splined profile SAE 9T - 20/40 DP</p>  <p>Disponibile per - available for: SAEAA</p>
<p>15 Scanalato DIN 5480 6 denti 12x9 DIN 5480 splined</p> <p>Coppia 30 Nm Torque 22 ft-lbs</p>	<p>Profilo scanalato DIN 5480 12x9 Z=6</p> <p>Splined profile DIN 5480 12x9 z=6</p>  <p>Disponibile per - available for: EUR - MC32</p>	<p>Profilo scanalato DIN 5480 12x9 Z=6</p> <p>Splined profile DIN 5480 12x9 z=6</p>  <p>Disponibile per - available for: SAEAA</p>

POMPE AD INGRANAGGI GRUPPO 1SP
GEAR PUMPS GROUP 1SP

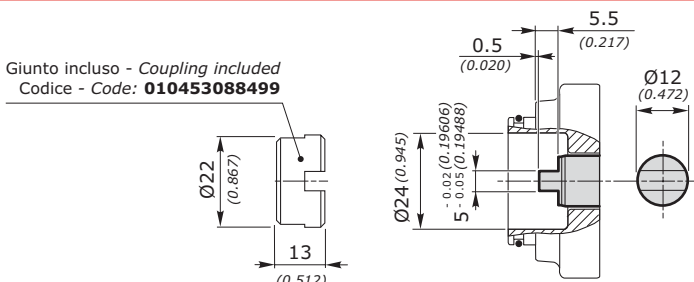
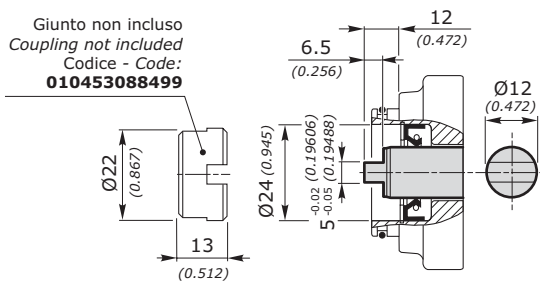
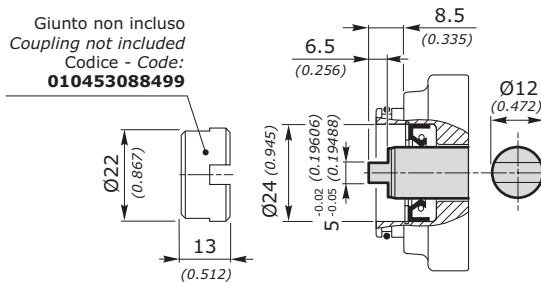
1SP	DIMENSIONI ALBERO - SHAFT DIMENSIONS	
<p>17 Fresato a dente frontale <i>Dihedral claw</i></p> <p>Coppia 25 Nm Torque 19 ft-lbs</p>	<p>Giunto incluso - Coupling included Codice - Code: 010453088499</p>  <p>Disponibile per - available for: E32BX - E32BC - E32CX - E32CC</p>	
<p>27 Fresato a dente frontale (con anello) <i>Dihedral claw (with sealing ring)</i></p> <p>Coppia 25 Nm Torque 19 ft-lbs</p>	<p>Giunto non incluso Coupling not included Codice - Code: 010453088499</p>  <p>Disponibile per - available for: EUR - MC32</p>	<p>Giunto non incluso Coupling not included Codice - Code: 010453088499</p>  <p>Disponibile per - available for: SAEAA</p>

POMPE AD INGRANAGGI GRUPPO 1SP
GEAR PUMPS GROUP 1SP
POSIZIONE CONNESSIONE • CONNECTION POSITION

 Rotazione destra - **D**
 Right rotation - **D**

 Rotazione sinistra - **S**
 Left rotation - **S**

0	1	3	4	2 (per - for MC32)	5 (per - for MC32)

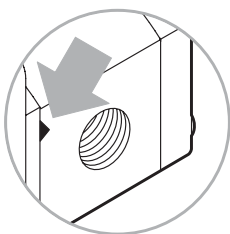
 Il segno del corpo indica il lato aspirazione per le pompe
 The sign on the body identify the suction side for the pumps



IN = ASPIRAZIONE - SUCTION
OUT = MANDATA - DELIVERY
TIPO CONNESSIONE • CONNECTION TYPE



 Le connessioni rappresentate corrispondono alle versioni standard; per connessioni differenti, contattare il nostro Ufficio Commerciale. *The connections type shown correspond to standard configuration; for different applications contact our Commercial Dept.*

1SP		POSIZIONE CONNESSIONE - CONNECTION POSITION					
		0	1	3	4	2	5
GAS	G	◇	◇	◇	◇	◇	◇
UNF	U	◇	◇	◇	◇	◇	◇
FLANGIATE	T	◇				◇	
FLANGED	N	◇				◇	

GAS	UNI ISO 228/1	SIGLA CODE	CIL. DISPL.	ASPIRAZIONE - SUCTION IN			MANDATA - DELIVERY OUT		
				A	B		A	B	
	G	G	009	G 3/8"	14 [mm] 0.552 [inch]	40 [Nm] 354 [in.lbs]	G 3/8"	14 [mm] 0.552 [inch]	40 [Nm] 354 [in.lbs]
			012						
			016						
			020						
			025						
			032						
			037						
			042						
			050						
			063						
			078						
098									

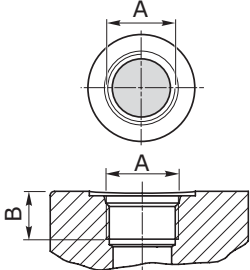
POMPE AD INGRANAGGI GRUPPO 1SP
GEAR PUMPS GROUP 1SP

UNF	ANSI/ASME B1.1	SIGLA CODE	CIL. DISPL.	ASPIRAZIONE - SUCTION IN			MANDATA - DELIVERY OUT			
				A	B		A	B		
	U	009								
		012	SAE 6 9/16"-18 UNF	13 [mm]	40 [Nm]	SAE 6 9/16"-18 UNF	13 [mm]	40 [Nm]		
		016		0.512 [inch]	354 [in.lbs]		0.512 [inch]	354 [in.lbs]		
		020								
		025								
		032								
		037								
		042	SAE 8 3/4"-14 UNF	15 [mm]	50 [Nm]	SAE 8 3/4"-14 UNF	15 [mm]	50 [Nm]		
		050		0.591 [inch]	443 [in.lbs]		0.591 [inch]	443 [in.lbs]		
		063								
		078								
		098								

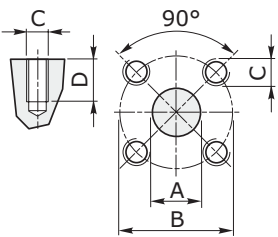
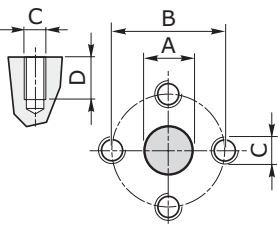
FLANGIATE FLANGED	ISO/R 262	SIGLA CODE	CIL. DISPL.	ASPIRAZIONE - SUCTION IN					MANDATA - DELIVERY OUT				
				A	B	C	D		A	B	C	D	
	T	009											
		012											
		016											
		020											
		025	12 [mm] 0.472 [inch]	30 [mm] 1.181 [inch]	M6	13 [mm] 0.512 [inch]	8 [Nm] 71 [in.lbs]	12 [mm] 0.472 [inch]	30 [mm] 1.181 [inch]	M6	13 [mm] 0.512 [inch]	8 [Nm] 71 [in.lbs]	
		032											
		037											
		042											
		050											
		063											
078													
098													
	N	009											
		012	10 [mm]	26 [mm]	M5	11 [mm]	7 [Nm]	10 [mm]	26 [mm]	M5	11 [mm]	7 [Nm]	
		016	0.394 [inch]	1.024 [inch]		0.433 [inch]	62 [in.lbs]	0.394 [inch]	1.024 [inch]		0.433 [inch]	62 [in.lbs]	
		020											
		025											
		032											
		037	13 [mm] 0.512 [inch]	30 [mm] 1.181 [inch]	M6	11 [mm] 0.433 [inch]	8 [Nm] 71 [in.lbs]	13 [mm] 0.512 [inch]	30 [mm] 1.181 [inch]	M6	11 [mm] 0.433 [inch]	8 [Nm] 71 [in.lbs]	
		042											
		050											
		063											
078													
098													