

CARATTERISTICHE TECNICHE TECHNICAL FEATURES

Pressione massima Maximum pressure	350 bar (5075 psi)
Portata nominale Nominal Flow	150 l/min (39,62 gpm)
Temperatura di esercizio Operating temperature	- 20 / +80 °C
Cavità Cavity	C045
Trafilamento interno Internal leakage	0,5 cc/min
Coppia Torque	60 Nm
Peso Weight	0,26 Kg

SCHEMA IDRAULICO HYDRAULIC SCHEME

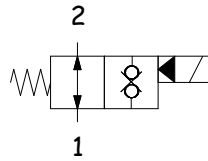

BOBINA COIL

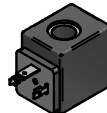

13-39
22 W

pag.20.0

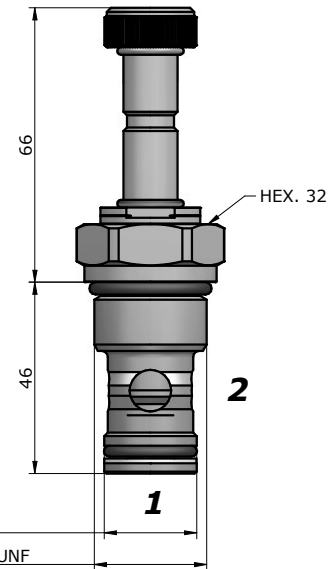

PRESTAZIONI PERFORMANCES

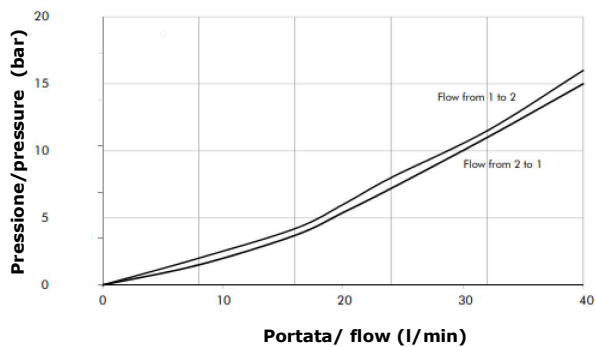

DESCRIZIONE DESCRIPTION

Quando la bobina è eccitata, la valvola blocca il passaggio in entrambe le direzioni.
Quando la bobina è diseccitata, la SVCP consente il flusso libero sia da 2 a 1 che da 1 a 2.

When the coil is energized, blocks flows in both directions.
When the coil is de-energized, the SVCP allows flow from 2 to 1 and from 1 to 2.

CODICE D'ORDINAZIONE ORDERING CODE

SVCP-S12-TD4- - - - -

GUARNIZIONI / SEAL
N = NBR

REGOLAZIONE / REGULATION
0 = SENZA COMANDO MANUALE / NO MANUAL OVERRIDE
2 = SPINGI E GIRA / PUSH AND TWIST
4 = PRESSIONE SU BOTTONE / PUSH BOTTON

TENSIONE / VOLTAGE
000 = SENZA BOBINA / WITHOUT COIL
D12 = 12 VDC
D24 = 24 VDC

TIPO CONNETTORE / CONNECTOR TYPE
0 = SENZA BOBINE / WITHOUT COIL
D = DIN 43650(STD)
G = DEUTSCH DT04-2P
A = AMP JUNIOR

DIMENSIONE CORPO /
SIZE DIMENSION
OMMETTERE/OMIT
300=1/2"BSP(pag.18.2)
400=3/4"BSP(pag.18.2)

MATERIALE CORPO /
MATERIAL BODY
OMMETTERE/OMIT
S = STEEL
A = ALLUMINUM

COLLETTORE 2 VIE PER VALVOLA SAE 08-10-12-16
2 WAY IN-LINE HOUSING FOR SAE 08-10-12-16 VALVE

OLEODINAMICA
2mp

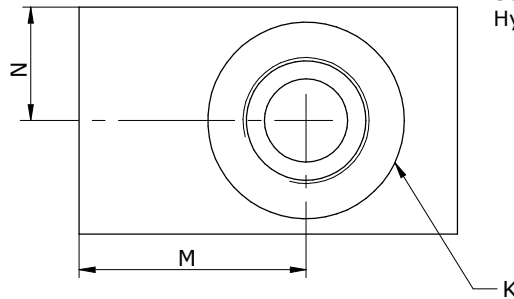
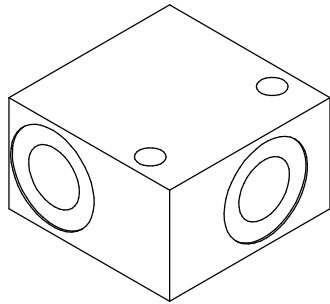

Schema idraulico
 Hydraulic diagram

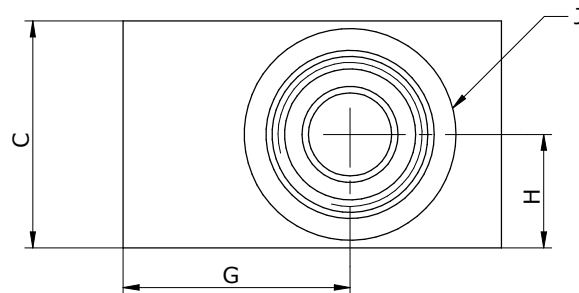
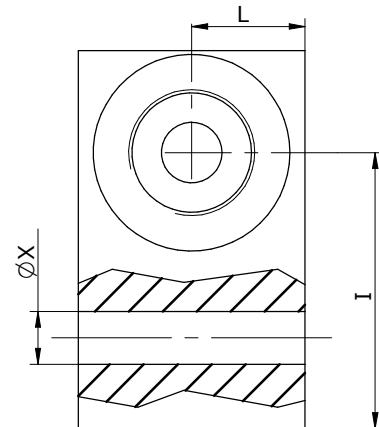
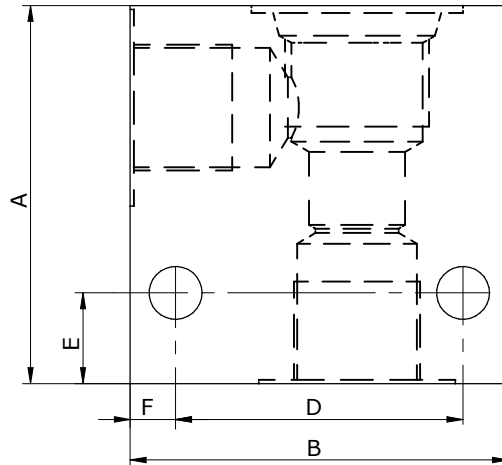
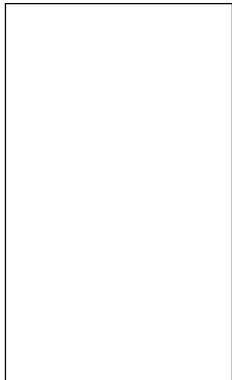
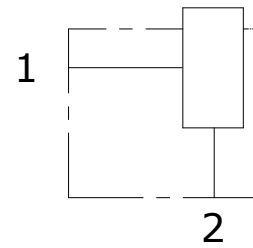

SIZE	A	B	C	D	E	F	G	H	I	L	M	N	J	CAVITY	K	X
HS 08-2	50	50	30	38	12	6	30	15	36.5	15	30	15	SAE 08-2	C007	1/4"BSP - 3/8"BSP	6.5
HS 10-2	60	60	40	48	12	6	37	20	41.5	20	37	20	SAE 10-2	C035	3/8"BSP - 1/2"BSP	6.5
HS 12-2	80	70	50	54	8	8	40	25	54.5	25	40	25	SAE 12-2	C045	1/2"BSP - 3/4"BSP	8.5
HS 16-2	80	80	50	60	10	10	45	25	55	25	45	25	SAE 16-2	C023	3/4"BSP - 1"BSP	11

HS - - - 2 - -

S = STEEL
A = ALUMINIUM

08 = 3/4-16UNF
10 = 7/8-14UNF
12 = 1.1/16-12 UNF
16 = 1.5/16-12 UNF

14 = 1/4"
38 = 3/8"
12 = 1/2"
34 = 3/4"
100 = 1"

Via Nicolò Copernico 12/c-d
 29027 Casoni Di Gariga - Podenzano (PC) Italy

www.oleodinamica2mp.it
 Tel +39 0523 523231

COILS

TENSIONE AMMISSIBILE VOLTAGE DUTY RATING	± 10%
FUNZIONAMENTO WORKING DUTY RATING	ED 100%
TEMPERATURA AMBIENTE WORKING ENV. TEMP.	-30°C + 50 °C
CLASSE ISOLAMENTO HEAT INSULATION CLASS	CLASSE H (180°)

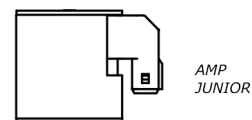
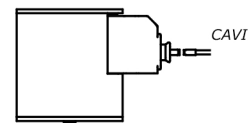
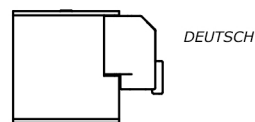
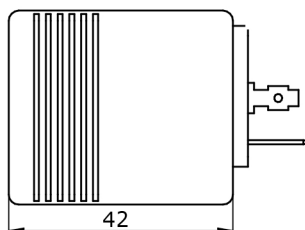
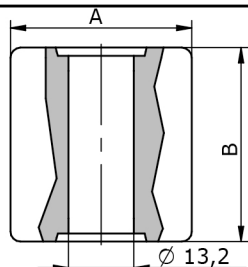

13-39

CL.	TUBO	TENS.	W/Va	A	B		CODICE	CONN		CODICE	CONN
H	13	12Vdc	18	30	39		SH18133930D012D0	DIN 43650		SH18133930D012G0	DEUTSCH
H	13	24Vdc	18	30	39		SH18133930D024D0	DIN 43650		SH18133930D024G0	DEUTSCH
H	13	26Vdc	18	30	39		SH18133930D026D0	DIN 43650		SH18133930D026G0	DEUTSCH
H	13	110 Rac	19	30	39		SF19133930R11D0	DIN 43650			
H	13	12Vdc	18	30	39		SH18133930D012A0	AMPJ		SH18133930D012C0	CAVI
H	13	24Vdc	18	30	39		SH18133930D024A0	AMPJ		SH18133930D024C0	CAVI
H	13	26Vdc	18	30	39		SH18133930D026A0	AMPJ		SH18133930D026C0	CAVI
H	13	12Vdc	22	36	39		SH20133936D012D0	DIN 43650		SH20133936D012G0	DEUTSCH
H	13	24Vdc	22	36	39		SH20133936D024D0	DIN 43650		SH20133936D024G0	DEUTSCH
H	13	26Vdc	22	36	39		SH20133936D026D0	DIN 43650		SH20133936D026G0	DEUTSCH
H	13	220Rac	22	36	39		SH20133936D012D0	DIN 43650			
H	13	12Vdc	22	36	39		SH20133936D012A0	AMPJ		SH20133936D012C0	CAVI
H	13	24Vdc	22	36	39		SH20133936D024A0	AMPJ		SH20133936D024C0	CAVI
H	13	26Vdc	22	36	39		SH20133936D026A0	AMPJ		SH20133936D026C0	CAVI

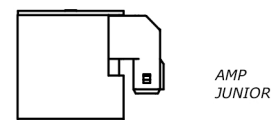
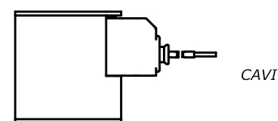
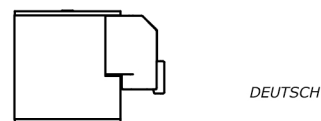
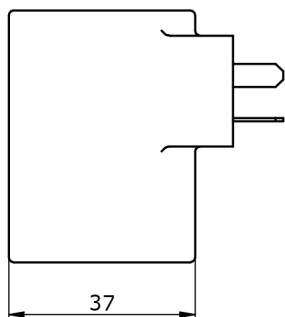
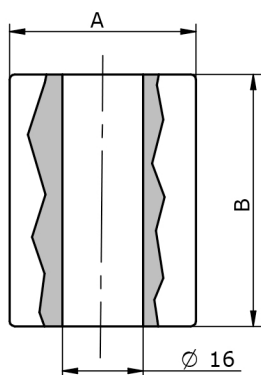

16-50

H	16	12Vdc	26	37	50		SH26165037D012D0	DIN 43650		SH26165037D012G0	DEUTSCH
H	16	24Vdc	26	37	50		SH26165037D024D0	DIN 43650		SH26165037D024G0	DEUTSCH
H	16	26Vdc	26	37	50		SH26165037D026D0	DIN 43650		SH26165037D026G0	DEUTSCH
H	16	12Vdc	26	37	50		SH26165037D012A0	AMPJ		SH26165037D012C0	CAVI
H	16	24Vdc	26	37	50		SH26165037D024A0	AMPJ		SH26165037D024C0	CAVI
H	16	26Vdc	26	37	50		SH26165037D026A0	AMPJ		SH26165037D026C0	CAVI