

## CARATTERISTICHE TECNICHE TECHNICAL CHARACTERISTICS

<b>Pressione massima</b> Maximum pressure	350 bar (5075 psi)
<b>Portata nominale</b> Nominal Flow	80 l/min (21,1 gpm)
<b>Temperatura di esercizio</b> Operating temperature	- 20°C /+ 110°C
<b>Cavità</b> Cavity	C035
<b>Trafilamento interno</b> Internal leakage	0,25cm <sup>3</sup> /min @ 30 bar
<b>Coppia</b> Torque	40 Nm
<b>Peso</b> Weight	0,16 Kg

## SCHEMA IDRAULICO HYDRAULIC SCHEME

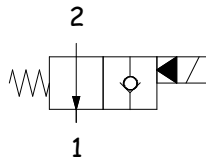

## BOBINA COIL

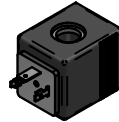

13-39  
22 W

pag. 20.0

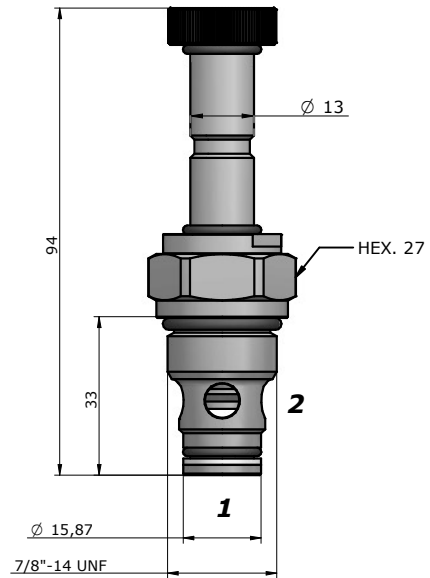

## PRESTAZIONI PERFORMANCES

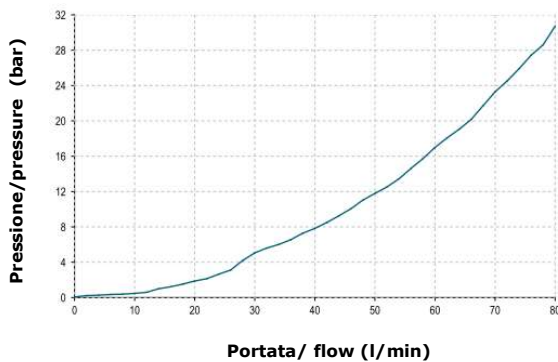

## DESCRIZIONE DESCRIPTION

Quando la bobina è eccitata, la valvola blocca il passaggio da 2 a 1.

Quando la bobina è diseccitata, la SVCP consente il flusso libero da 2 a 1, mentre lo blocca da 1 a 2.

When the coil is energized, blocking flow from 2 to 1.

When the coil is de-energized, the SVCP allows flow from 2 to 1, while flow from 1 to 2 is severely restricted.

## CODICE D'ORDINAZIONE ORDERING CODE

# SVCP-S10-TS2- - - - -

GUARNIZIONI / SEAL  
N = NBR

REGOLAZIONE / REGULATION  
0 = SENZA COMANDO MANUALE / NO MANUAL OVERRIDE  
2 = SPINGI E GIRA / PUSH AND TWIST

TENSIONE / VOLTAGE  
000 = SENZA BOBINA / WITHOUT COIL  
D12 = 12 VDC  
D24 = 24 VDC

TIPO CONNETTORE / CONNECTOR TYPE  
0 = SENZA BOBINE / WITHOUT COIL  
D = DIN 43650 (STD)  
G = DEUTSCH DT04-2P  
A = AMP JUNIOR

DIMENSIONE CORPO /  
SIZE BODY  
**OMETTERE/OMIT**  
200=BSP3/8" (pag.18.2)  
300=BSP1/2" (pag.18.2)  
301=BSP1/2" (pag.18.7)  
401=BSP3/4" (pag.18.7)

MATERIALE CORPO /  
MATERIAL BODY  
**OMETTERE/OMIT**  
S = STEEL  
A = ALLUMINIUM

**COLLETTORE 2 VIE PER VALVOLA SAE 08-10-12-16**  
**2 WAY IN-LINE HOUSING FOR SAE 08-10-12-16 VALVE**

**OLEODINAMICA**  
**2mp**

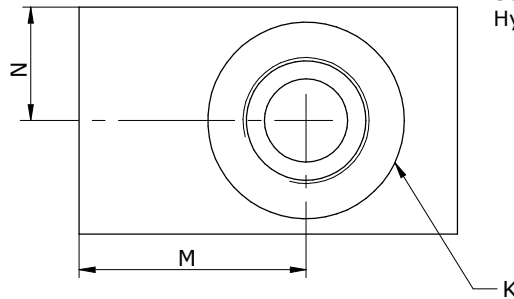
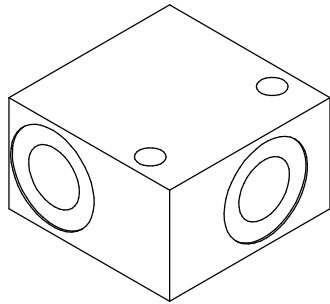

Schema idraulico  
Hydraulic diagram

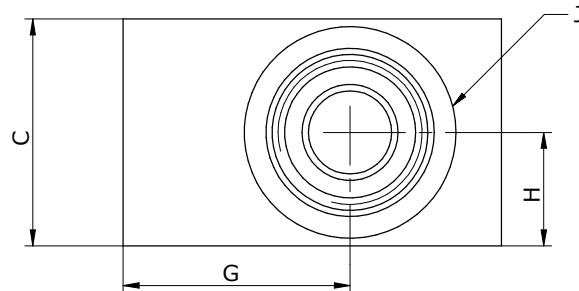
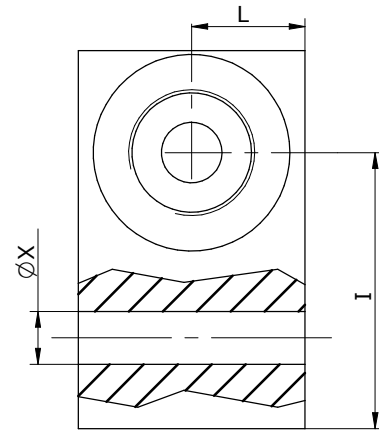
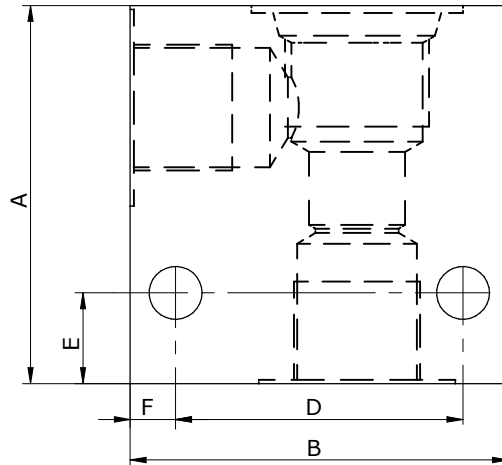
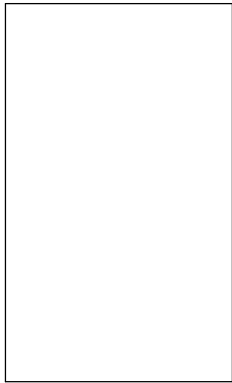
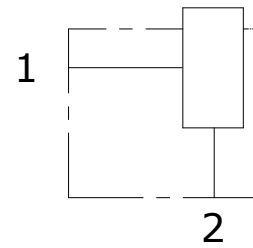

SIZE	A	B	C	D	E	F	G	H	I	L	M	N	J	CAVITY	K	X
HS 08-2	50	50	30	38	12	6	30	15	36.5	15	30	15	SAE 08-2	C007	1/4"BSP - 3/8"BSP	6.5
HS 10-2	60	60	40	48	12	6	37	20	41.5	20	37	20	SAE 10-2	C035	3/8"BSP - 1/2"BSP	6.5
HS 12-2	80	70	50	54	8	8	40	25	54.5	25	40	25	SAE 12-2	C045	1/2"BSP - 3/4"BSP	8.5
HS 16-2	80	80	50	60	10	10	45	25	55	25	45	25	SAE 16-2	C023	3/4"BSP - 1"BSP	11

**HS - - - 2 - -**

**S** = STEEL  
**A** = ALUMINIUM

**08** = 3/4-16UNF  
**10** = 7/8-14UNF  
**12** = 1.1/16-12 UNF  
**16** = 1.5/16-12 UNF

**14** = 1/4"  
**38** = 3/8"  
**12** = 1/2"  
**34** = 3/4"  
**100** = 1"

Via Nicolò Copernico 12/c-d  
 29027 Casoni Di Gariga - Podenzano (PC) Italy

www.oleodinamica2mp.it  
 Tel +39 0523 523231

# COILS

<b>TENSIONE AMMISSIBILE</b> VOLTAGE DUTY RATING	± 10%
<b>FUNZIONAMENTO</b> WORKING DUTY RATING	ED 100%
<b>TEMPERATURA AMBIENTE</b> WORKING ENV. TEMP.	-30°C + 50 °C
<b>CLASSE ISOLAMENTO</b> HEAT INSULATION CLASS	CLASSE H (180°)

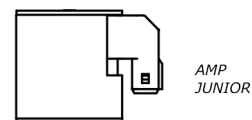
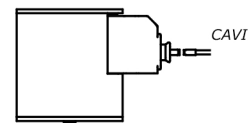
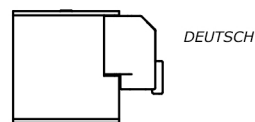
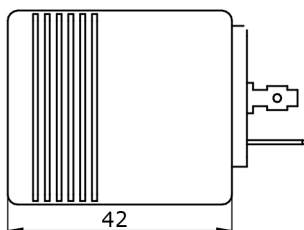
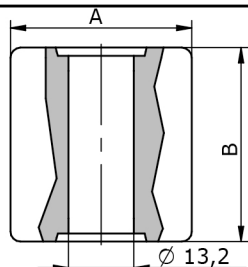

13-39

CL.	TUBO	TENS.	W/Va	A	B		CODICE	CONN		CODICE	CONN
H	13	12Vdc	18	30	39		SH18133930D012D0	DIN 43650		SH18133930D012G0	DEUTSCH
H	13	24Vdc	18	30	39		SH18133930D024D0	DIN 43650		SH18133930D024G0	DEUTSCH
H	13	26Vdc	18	30	39		SH18133930D026D0	DIN 43650		SH18133930D026G0	DEUTSCH
H	13	110 Rac	19	30	39		SF19133930R11D0	DIN 43650			
H	13	12Vdc	18	30	39		SH18133930D012A0	AMPJ		SH18133930D012C0	CAVI
H	13	24Vdc	18	30	39		SH18133930D024A0	AMPJ		SH18133930D024C0	CAVI
H	13	26Vdc	18	30	39		SH18133930D026A0	AMPJ		SH18133930D026C0	CAVI
H	13	12Vdc	22	36	39		SH20133936D012D0	DIN 43650		SH20133936D012G0	DEUTSCH
H	13	24Vdc	22	36	39		SH20133936D024D0	DIN 43650		SH20133936D024G0	DEUTSCH
H	13	26Vdc	22	36	39		SH20133936D026D0	DIN 43650		SH20133936D026G0	DEUTSCH
H	13	220Rac	22	36	39		SH20133936D012D0	DIN 43650			
H	13	12Vdc	22	36	39		SH20133936D012A0	AMPJ		SH20133936D012C0	CAVI
H	13	24Vdc	22	36	39		SH20133936D024A0	AMPJ		SH20133936D024C0	CAVI
H	13	26Vdc	22	36	39		SH20133936D026A0	AMPJ		SH20133936D026C0	CAVI

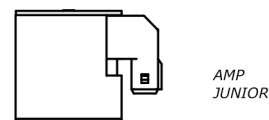
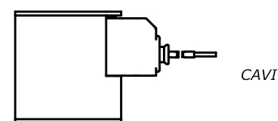
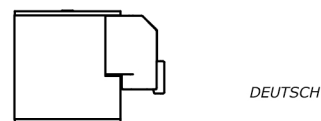
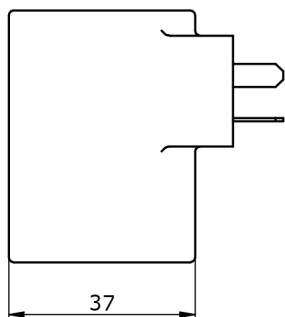
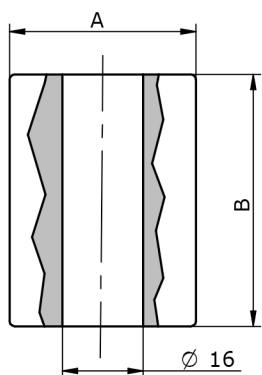

16-50

H	16	12Vdc	26	37	50		SH26165037D012D0	DIN 43650		SH26165037D012G0	DEUTSCH
H	16	24Vdc	26	37	50		SH26165037D024D0	DIN 43650		SH26165037D024G0	DEUTSCH
H	16	26Vdc	26	37	50		SH26165037D026D0	DIN 43650		SH26165037D026G0	DEUTSCH
H	16	12Vdc	26	37	50		SH26165037D012A0	AMPJ		SH26165037D012C0	CAVI
H	16	24Vdc	26	37	50		SH26165037D024A0	AMPJ		SH26165037D024C0	CAVI
H	16	26Vdc	26	37	50		SH26165037D026A0	AMPJ		SH26165037D026C0	CAVI