

FLOWFIT 12VDC SINGLE ACTING HYDRAULIC POWER PACKS

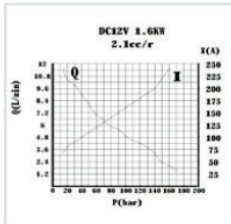

SINGLE ACTING WIRING DIAGRAM

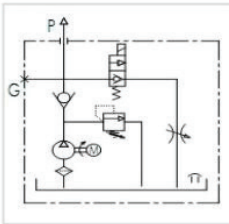
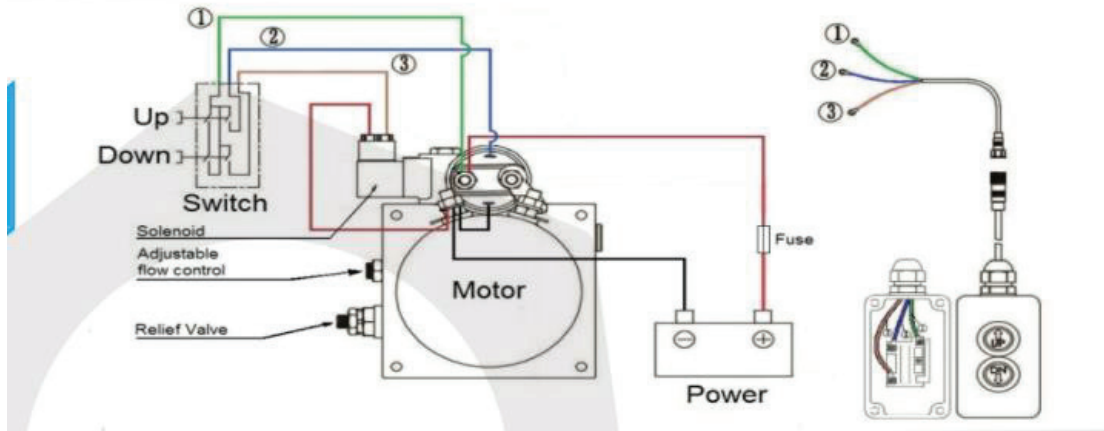

SINGLE ACTING (WITH REMOTE) WIRING DIAGRAM

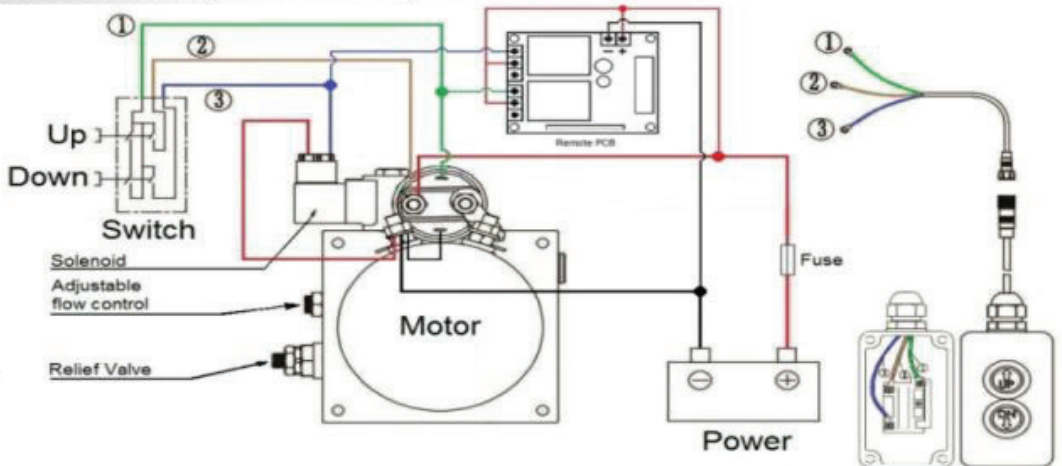

4.5 LITRE POWER PACK DIMENSIONS

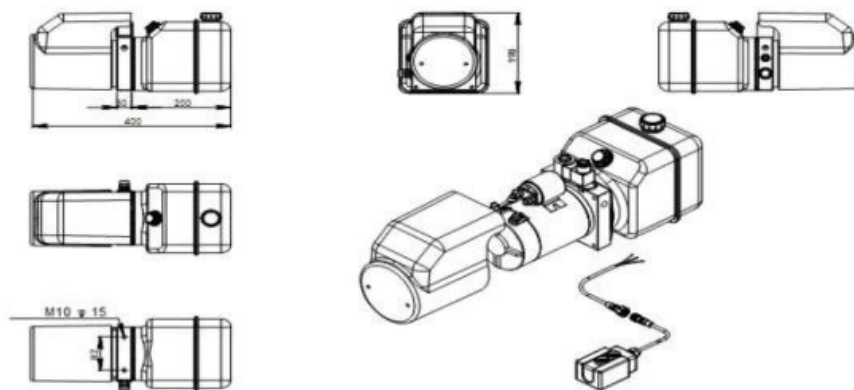

8.0 LITRE POWER PACK DIMENSIONS

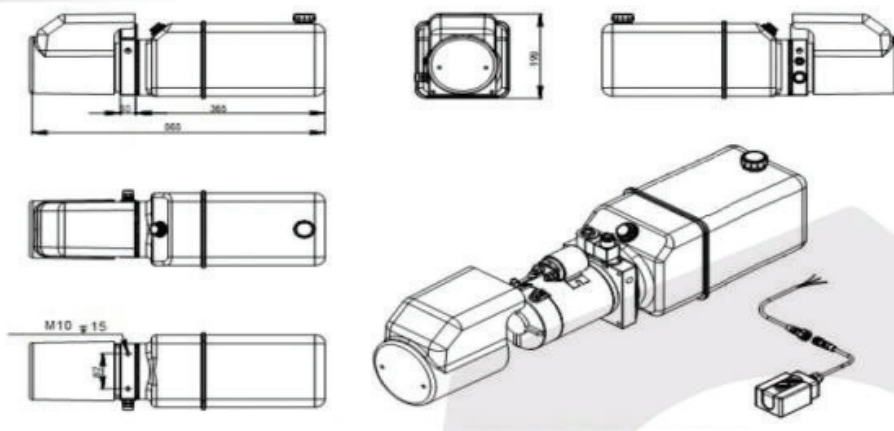

FLOWFIT® Technical Data

700 Series Standard Hydraulic Cylinders



CHARACTERISTICS

- Maximum working pressure: 200 bar
- Maximum testing pressure: 300 bar
- Maximum working speed: 0.5 m/s
- Working temperature: -30 °C to +90 °C
- Oil: mineral hydraulic

MATERIALS

- Rod: chrome plated steel F-1140, minimum chrome layer thickness 20 micron, roughness Ra < 0,2, minimum surface hardness 900 HV, corrosion resistance minimum 200 hours in neutral saline fog according to ISO9227 rating 9
- Tube: steel ST-52-3, DIN 2393, inside diameter tolerance ISO H9, roughness Ra <0,8 micron.
- Guide-bushing: steel F-1140 nitrated (nitride hardening)
- Piston: steel F-1140

SEALS

- Guide-bushing:
 - Dynamic: compact polyurethane rod-seal, double lip. NBR metal wiper seal
 - Static: NBR 90 shore o-ring
- Piston:
 - Dynamic: compact double-acting polyurethane seal, plus nitrile o-ring as activator
Special polyacetal guides reinforced with glass fibre.
 - Static: polyamide locking sealing guide

FINISHING

Black prime painting

RECOMMENDATIONS

- Protect the cylinder circuit with a relief valve set at 200 bar
- Check the oil cleanness (pollution), and prevent it from having strange objects (place a filter on the cylinder circuit)
- Bleed the circuit by slightly loosening the cylinder fittings before starting-up
- Do not weld on the cylinder tube
- Before welding on the rod or on the bottom, please dismount the cylinder. - In case you need to store the cylinders for a long period of time, please avoid outdoor storage. If not possible, the rod must be completely retracted or it must be greased instead
- For high-pressure cleaning or blasting on the cylinder, the rod and the oil-ports must be suitably protected.
- For double-acting cylinders working as single acting, we recommend to connect the non-used oil-port to tank
- In case you need to dismount the cylinder, please note that the piston is screwed onto the rod end and fixed with industrial glue, so you must use also industrial glue when mounting again

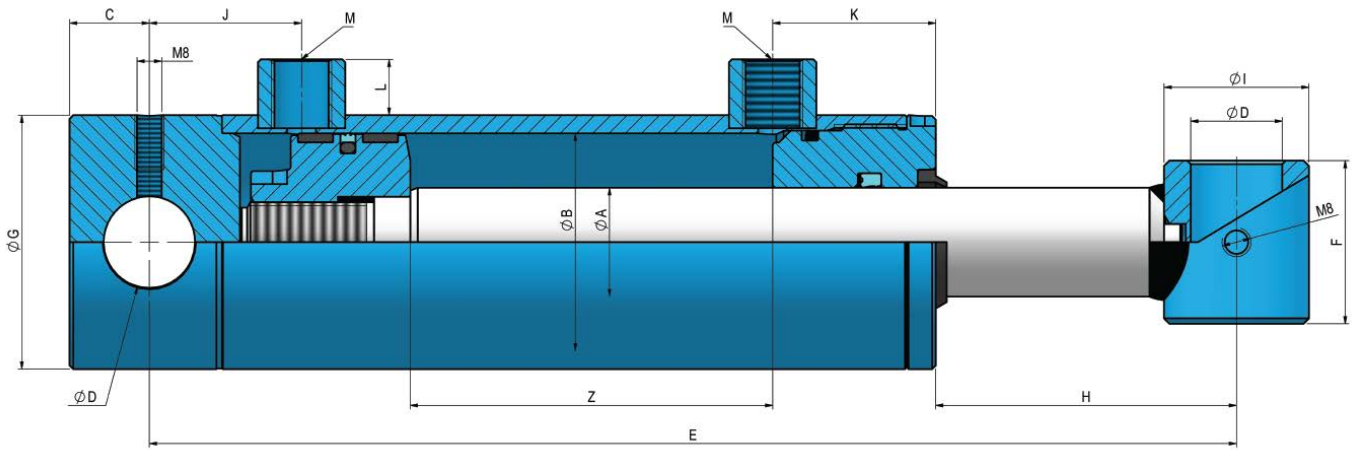

SERIES 700

REF.	ØA	ØB	STROKE z	E	C	D	F	G	H	I	J	K	L	M BSP	VOL (L)	SEALS JOINTS	WEIGHT (kg)
704/100	40	70	100	310	28	30.5	55	80	82	50	48	49	15	3/8	0.39	J74N	8.4
704/2	40	70	200	410	28	30.5	55	80	82	50	48	49	15	3/8	0.77	J74N	10.0
704/250	40	70	250	460	28	30.5	55	80	82	50	48	49	15	3/8	0.96	J74N	11.2
704/3	40	70	300	510	28	30.5	55	80	82	50	48	49	15	3/8	1.15	J74N	11.9
704/350	40	70	350	560	28	30.5	55	80	82	50	48	49	15	3/8	1.35	J74N	12.9
704/4 €	40	70	400	610	28	30.5	55	80	82	50	48	49	15	3/8	1.54	J74N	13.7
704/450	40	70	450	660	28	30.5	55	80	82	50	48	49	15	3/8	1.73	J74N	15
704/5	40	70	500	710	28	30.5	55	80	82	50	48	49	15	3/8	1.92	J74N	15.6
704/550	40	70	550	760	28	30.5	55	80	82	50	48	49	15	3/8	2.12	J74N	16.9
704/6	40	70	600	810	28	30.5	55	80	82	50	48	49	15	3/8	2.31	J74N	17.5
704/7	40	70	700	910	28	30.5	55	80	82	50	48	49	15	3/8	2.69	J74N	19.4
704/800	40	70	800	1010	28	30.5	55	80	82	50	48	49	15	3/8	3.08	J74N	21.5
704/900	40	70	900	1110	28	30.5	55	80	82	50	48	49	15	3/8	3.46	J74N	23.6
704/1000	40	70	1000	1210	28	30.5	55	80	82	50	48	49	15	3/8	3.85	J74N	25.3
704/1100	40	70	1100	1310	28	30.5	55	80	82	50	48	49	15	3/8	4.23	J74N	27.4
704/1200	40	70	1200	1410	28	30.5	55	80	82	50	48	49	15	3/8	4.62	J74N	29.3
704/1300	40	70	1300	1510	28	30.5	55	80	82	50	48	49	15	3/8	5.00	J74N	31.2
704/1400	40	70	1400	1610	28	30.5	55	80	82	50	48	49	15	3/8	5.39	J74N	33.1
704/1500	40	70	1500	1710	28	30.5	55	80	82	50	48	49	15	3/8	5.77	J74N	35.0

BUCKLING

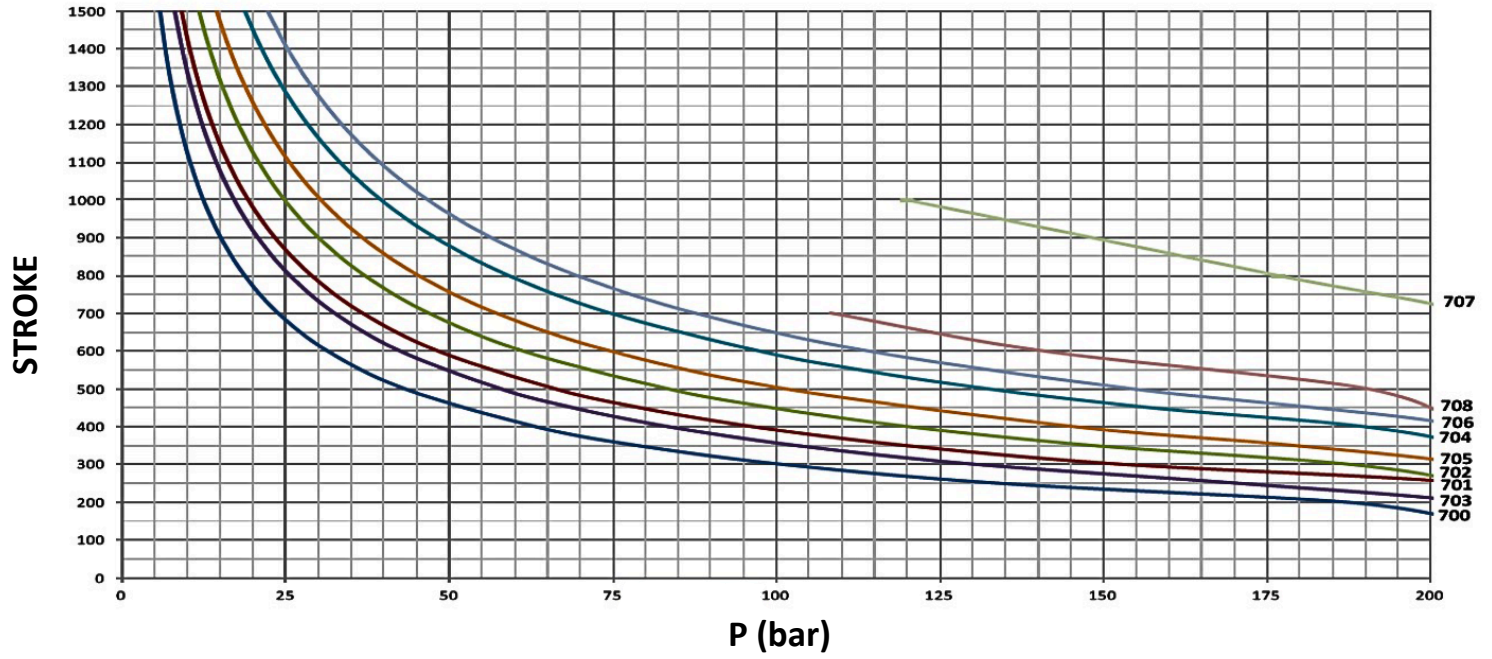

Data calculated according to euler. Safety coefficient 3.5

UPWARD THRUST

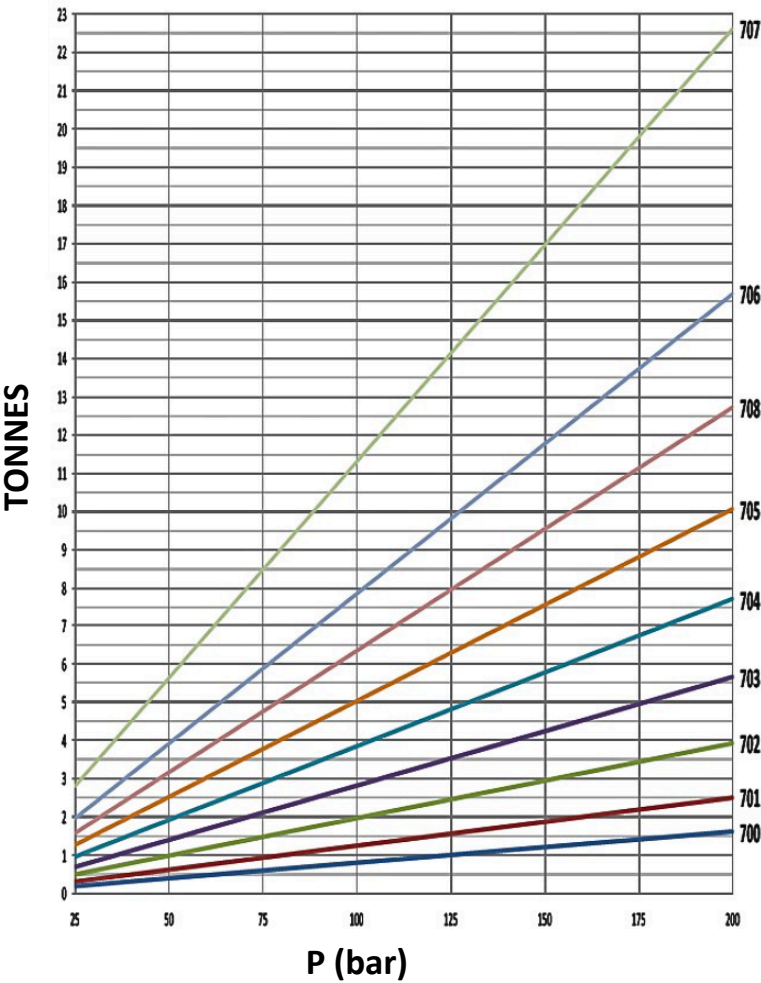

TRACTIVE EFFORT

